

INVESTIGATION OF THE PERFORMANCE CHARACTERISTICS OF AN AMMONIA-WATER ABSORPTION CHILLER IN A TRIGENERATION SYSTEM ARRANGEMENT

**INyoman Suamir^{a*}, Savvas A. Tassou^a, Abas Hadawey^a,
Issa Chaer^b, Doug Marriott^c**

^a School of Engineering and Design, Brunel University, Uxbridge, Middlesex, UB8 3PH, UK
* Tel.: +44 1895266851; Fax: +44 1895269782. E-mail address: INyoman.Suamir@brunel.ac.uk

^b Faculty of Engineering, Science and the Built Environment, London South Bank University, UK

^c Doug Marriott Associates, UK

ABSTRACT

Trigeneration systems have been used in a number of applications including commercial buildings and industrial facilities. Most of these have been for space cooling applications with a smaller number for refrigeration applications in the food processing industry which requires temperatures below 0°C. This paper is concerned with the investigation and development of modular trigeneration systems for food industry applications based on the integration of microturbines and ammonia water absorption refrigeration systems. Specifically, the paper presents results of experimental investigations on the performance of a 12 kW capacity ammonia-water absorption refrigeration system driven by thermal energy recovered from the exhaust gases of a microturbine in a trigeneration arrangement. The heat transfer between the microturbine exhaust heat exchanger and the generator of the absorption refrigeration system is performed by a heat transfer fluid in a closed heat transfer loop. Tests were performed at different brine temperatures and heat transfer fluid temperatures. The performance of the unit was evaluated and found to compare favourably with the performance of a directly gas fired absorption chiller. In addition, the overall efficiency of the trigeneration system was also evaluated.

Keywords: ammonia-water absorption chiller, trigeneration, performance characteristic, heat transfer fluid

INTRODUCTION

Absorption cooling is a technology that uses heat instead of electricity to produce cooling. The heat to the generator of the absorption chiller can be provided directly by a gas fired system or indirectly using a heat transfer fluid. Rossa et al. 2007, reported on the use of a thermal fluid system to drive the generator of an ammonia-water absorption chiller. The authors showed that the system could start producing refrigeration at a thermal fluid temperature of 120 °C, and achieved a COP of around 0.26. Florides et al. 2002, reported on an ammonia-water system with air cooled absorber and condenser that required a generator temperature in the range of 125 to 170°C.

The combination of absorption refrigeration with a CHP plant enables the use of the generated heat to produce cooling and refrigeration. Bassols et al. 2002, illustrated examples of typical ammonia-water plant in the food industry. Jalalzadeh-Azar et al. 2002, reported on successful integration of cogeneration plant with absorption coolers for industrial and commercial applications. These systems have not been applied widely to the food industry, however, due to the unavailability of small size low temperature and low cost absorption refrigeration systems off-the-shelf.

The energy and carbon savings from CHP installations can be as high as 30% compared to separate heat and power generation but this depends on many factors such as the size of the scheme and the nature of the heat load (DTI, 2007). For maximum savings there needs to be simultaneous demand of heat and electricity and a fairly constant heat demand throughout the year. In many applications where the demand for heat does not remain constant throughout the year, the utilisation efficiency of a CHP plant can be increased if the excess heat is used to drive thermally driven (sorption) refrigeration systems. The integration of CHP with sorption refrigeration technologies is known as Combined Heating Refrigeration and Power (CHRP) or trigeneration.

Tassou et al. 2007 and Sugiarta et al. 2008 showed that trigeneration technology based on a micro gas turbine integrated with an absorption refrigeration system can provide promising economic and environmental benefits when used in supermarket applications. The authors indicated that payback periods of between 3 and 5 can be achieved for gas to electricity price ratios less than 0.3. Arteconi et al. 2009 reported that trigeneration systems in supermarket applications can produce primary energy savings of 56% with payback period of less than 5 years.

This paper presents results of experimental investigations on the performance of a 12 kW capacity ammonia-water absorption refrigeration system driven by thermal energy recovered from the exhaust gases of a microturbine in a trigeneration arrangement. The heat transfer between the microturbine exhaust heat exchanger and the generator of the absorption unit system is performed by a heat transfer fluid in a closed heat transfer loop arrangement.

TEST FACILITY

The trigeneration test facility incorporates three main modules; CHP module, absorption refrigeration system module, and a refrigeration load module. These modules which are shown in Figure 1 were comprehensively instrumented to measure temperatures, pressures and flowrates to enable the performance of the unit to be evaluated.

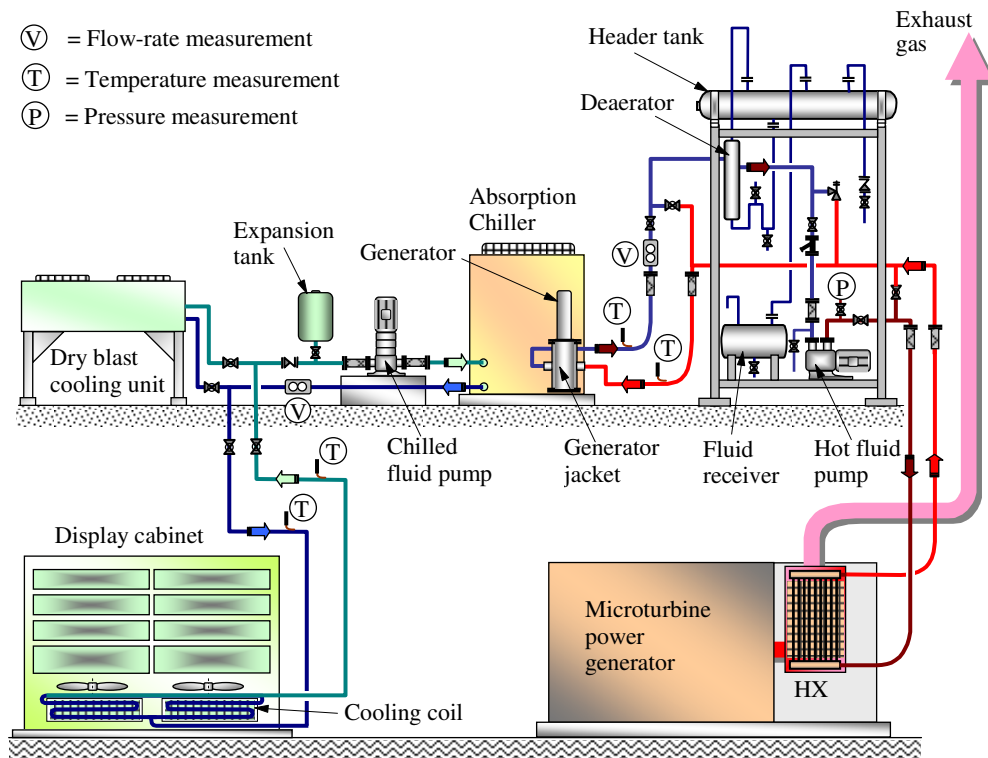

Figure 1: Schematic diagram of test facility using oil as the heat transfer medium between the microturbine and absorption refrigeration system

The CHP module is based on a Bowman 80 kWe recuperated microturbine generation package MTG80RC-G with in-built boiler heat exchanger (exhaust heat recovery heat exchanger). The microturbine consists of a single stage radial compressor, single radial turbine within an annular combustor and a permanent magnet rotor (alternator) all on the same rotor shaft. Other systems in the engine bay include the fuel management system and the lubrication/cooling system. Heat recovery from the exhaust gases is performed in a stainless steel flue-gas/liquid heat exchanger. The heat recovery fluid is Diphyl-THT high performance synthetic heat transfer fluid that can operate at temperatures up to 340°C.

The absorption refrigeration system employed is a packaged gas fired ROBUR ACF-60LB chiller. The performance of the unit in its gas fired format, was established from tests in the laboratory. For brine flow

temperatures between $-11\text{ }^{\circ}\text{C}$ and $+3\text{ }^{\circ}\text{C}$, the refrigeration capacity of the unit was found to vary from 8.5 kW to 15 kW and the COP from 0.32 to 0.57 (Tassou et. al. 2008).

To be used in a trigeneration arrangement the generator of the absorption unit was modified to be heated by the heat transfer fluid that flows in a loop between the microturbine exhaust heat recovery heat exchanger and the absorption refrigeration system generator as shown in Figure 1. The modification included the replacement of the gas burner with a heat transfer jacket around the generator as shown in Figure 2. The jacket design and heat transfer fluid flow around it were optimised using Computational Fluid Dynamics (CFD).

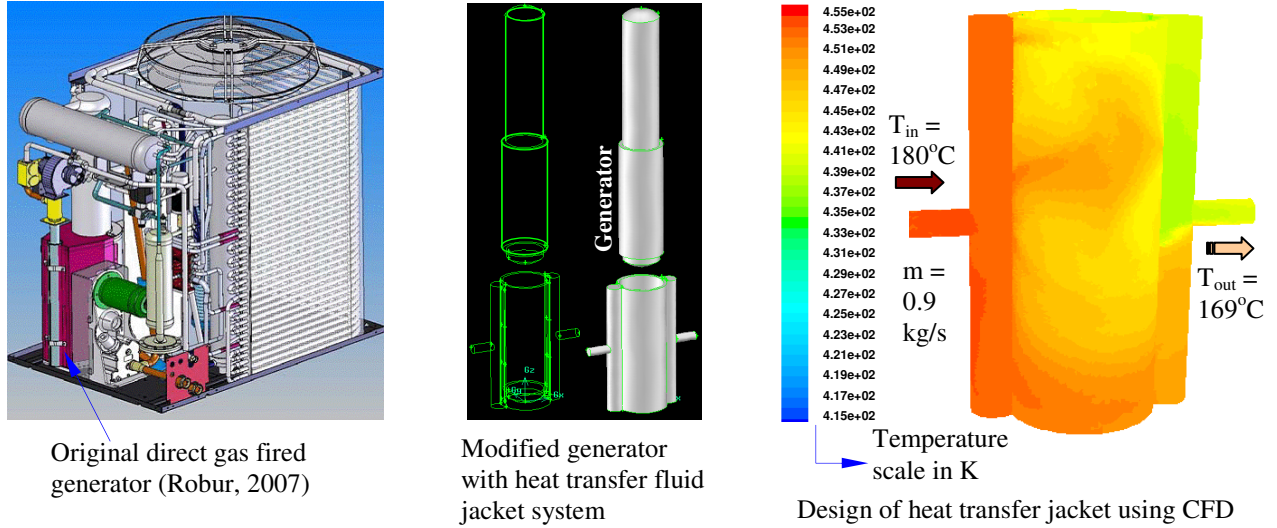

Figure 2: Design modification of the absorption chiller to operate with heat recovered from the exhaust gases of the microturbine

METHODOLOGY AND TEST RESULTS

Tests were performed at different brine temperatures at the refrigeration system evaporator and heat transfer fluid temperatures at the generator. Brine delivery temperatures ranged between -10.4 to $-2.3\text{ }^{\circ}\text{C}$. The microturbine operated at full load with 100% recuperation. Tests at different heat transfer fluid temperatures between 187 and $217\text{ }^{\circ}\text{C}$ were performed by changing the power output of the microturbine from 10 to 80 kW whilst the brine flow temperature was maintained at $-8\text{ }^{\circ}\text{C}$. The following parameters were recorded: power output, fuel consumption and exhaust gas temperature of the microturbine; temperatures, pressures and flowrates of the brine and heat transfer fluid; pressures and temperatures at various points of the refrigeration cycle of the absorption chiller; power consumption of the heat transfer fluid pump and absorption refrigeration system brine pump. These parameters were used to determine the COP of the refrigeration system, the electrical generation efficiency of the microturbine system and the overall efficiency of the system operating in a combined refrigeration and power mode (CRP) and combined refrigeration, heating and power mode (trigeneration). Equations 1 to 5 were used for the calculations as follows:

$$COP = \frac{Q_c}{Q_g} = \frac{m_b \cdot Cp_b \cdot (T_{bi} - T_{bo})}{m_o \cdot Cp_o \cdot (T_{oi} - T_{oo})} \quad [1]$$

Including the power consumption of the heat transfer fluid pump the system COP is given by ,

$$COP_s = \frac{Q_c}{Q_g + W_{pump}} = \frac{m_b \cdot Cp_b \cdot (T_{bi} - T_{bo})}{m_o \cdot Cp_o \cdot (T_{oi} - T_{oo}) + W_{pump}} \quad [2]$$

$$\eta_e = \frac{W_e}{W_f} = \frac{3600 \cdot W_e}{1000 \cdot \dot{V} \cdot CV} \times 100 \quad (\%) \quad [3]$$

$$\eta_{CRP} = \frac{W_e + Q_c}{W_f} = \frac{3600 \cdot (W_e + Q_c)}{1000 \cdot \dot{V} \cdot CV} \times 100 \quad (\%) \quad [4]$$

$$\eta_{TRI} = \frac{W_e + Q_c + Q_h}{W_f} = \frac{3600 \cdot (W_e + Q_c + Q_h)}{1000 \cdot \dot{V} \cdot CV} \times 100 \quad (\%) \quad [5]$$

The results of a start up test for the oil fired unit are shown in Figure 3. The Figure shows the variation of the heat transfer fluid (HTF) temperature and the brine temperature entering and leaving the evaporator with time. It can be seen that at start up of the gas turbine unit the HTF temperature increased almost linearly and reaches 150 °C approximately 15 minutes from start up. The absorption unit started to produce refrigeration at this point with average HTF temperature around the generator of 145°C and average generator surface temperature 134.5°C. The HTF temperature continued to rise reaching a maximum of approximately 210 °C approximately 75 minutes from start up.

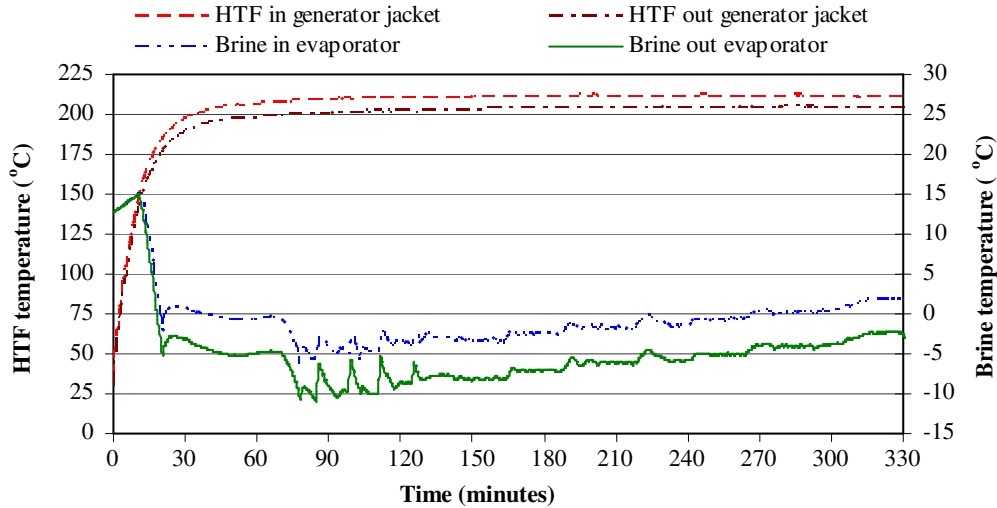

Figure 3: Temperature profile of HTF and brine of the plant at 80 kW power output and ambient temperature 9-11°C

The performance of the absorption unit, in its gas fired format, was established from tests in the laboratory. For brine flow temperatures between -11 °C and +3 °C, the refrigeration capacity varied from 8.5 kW to 15 kW and the COP from 0.32 to 0.57 (Tassou et al, 2008).

The modified unit performs as well if not better than the gas fired unit. At brine flow temperature of -8.0 °C both units have a refrigeration capacity of 12 kW. If the heat transfer fluid pump power is taken into consideration, both units will have a COP of around 0.53. The influence of the HTF and brine delivery temperature on the performance of the absorption refrigeration unit is shown in Figure 4. It can be seen that as the HTF temperature increases the refrigeration capacity of the absorption refrigeration system increases from around 10 kW at a HTF temperature of 167 °C to 13 kW at HTF temperature of 217 °C. The COP of the system initially increases reaching maximum at HTF temperature of 195 °C, and then begins to reduce. Maximum refrigeration system COP of 0.73 is achieved at HTF temperature of 195 °C at a brine flow temperature of -8°C. The overall system COP which includes the HTF pump power follows closely the variation of the refrigeration system COP, reaching a maximum of 0.6 at HTF temperature of 195 °C.

Figure 4 also shows that the refrigeration capacity of the absorption system is not influenced by the brine delivery temperature. The brine temperature, however, has an influence on the system COP which

increases as the brine delivery temperature reduces, reaching a plateau at a brine delivery temperature of $-4.0\text{ }^{\circ}\text{C}$.

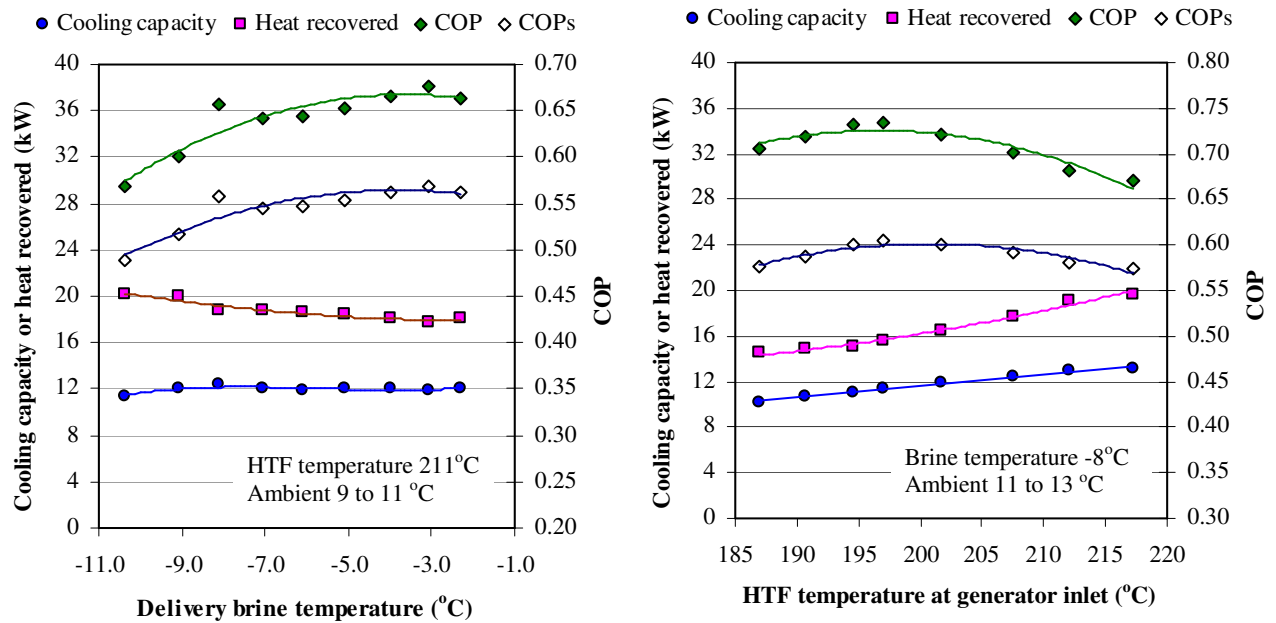

Figure 4: Performance of absorption refrigeration unit at different brine delivery and HTF temperatures

TRIGENERATION SYSTEM ARRANGEMENT

The heat required by the absorption chiller used in the tests was much lower than the heat available in the exhaust gases of the microturbine. To establish the refrigeration and heating potential of the trigeneration plant a spreadsheet based simulation was performed using the performance parameters and characteristics established from the experimental programme.

A proposed trigeneration system arrangement for food retail applications is illustrated in Figure 5. The system is based on an 80 kW_e recuperated microturbine with two identical boiler heat exchangers installed in series. This configuration can minimise complexity in regulating the exhaust gas flow and provides constant HTF temperature to the absorption refrigeration system. It can be seen that the system can generate 45 kW of refrigeration and 93 kW of heat for space and domestic hot water heating.

Figure 6 shows the influence of the HTF flow rate on the performance of the refrigeration system assuming full load operation of the microturbine, a return HTF temperature of $189\text{ }^{\circ}\text{C}$ and ambient temperature of $12\text{ }^{\circ}\text{C}$. The heat recovered from the exhaust gases increases slightly with HTF temperature as well as the refrigeration capacity of the absorption refrigeration system at the expense though of increased HTF pump power.

The influence of the HTF flowrate on the system efficiency is shown in Figure 7. It can be seen that the HTF flowrate has little impact on the overall performance of the system. The power generation, refrigeration, heating and overall system efficiency remain fairly constant over a wide range of HTF flow rate from 2.5 to 6.5 kg/s . The overall efficiency of the system is 75% . Cooling efficiency of the trigeneration plant can be improved up to 19% when the temperature of the HTF entering generator is set at about $180\text{ }^{\circ}\text{C}$, but it can reduce the overall efficiency of the plant. For optimum efficiency and savings, the plant capacity needs to be designed in accordance with simultaneous demand of cooling, heating and electricity.

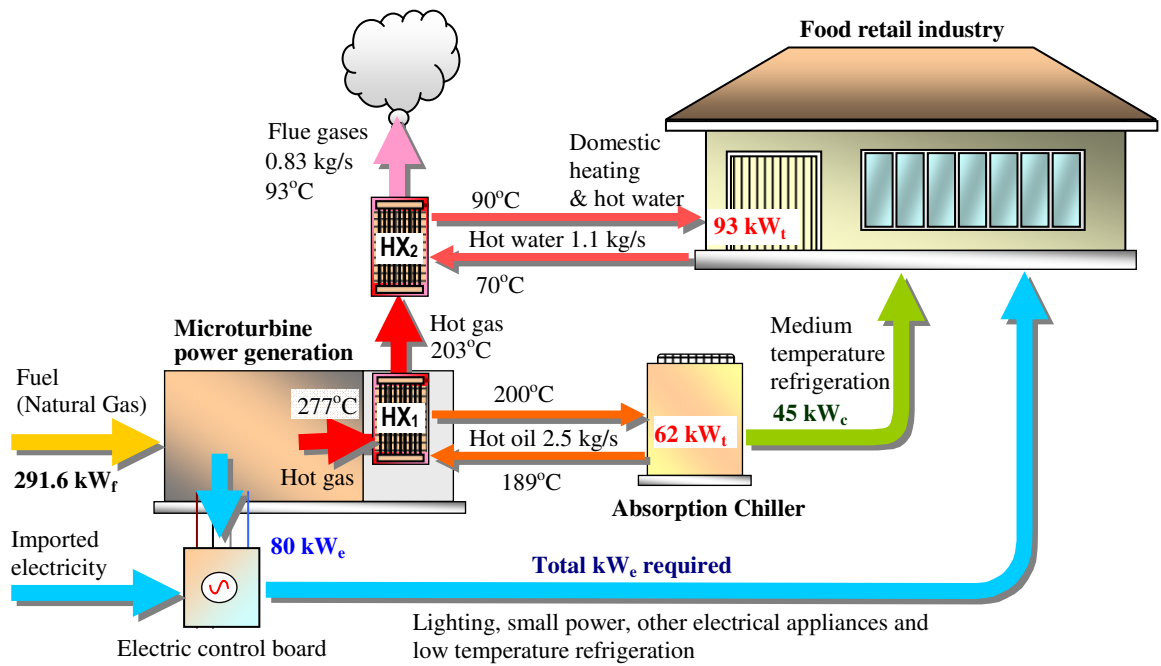

- Assumptions:
- HTF-transport heat losses 70 W/m (steel pipe 80 mm and HTF-circuit length 20 m)
 - $HX_1 = HX_2$ are 2-2 shell and coiled tube heat exchanger with heat transfers area 12 m^2
 - HX_1 and HX_2 are installed adjacent to each other, heat losses in HX and duct is not considered
 - Temperature drop in the hot water system considered 20 K and ambient temperature 12°C

Figure 5: Estimated capacity of a trigeneration plant utilizing an 80 kW microturbine power generation for food retail industry

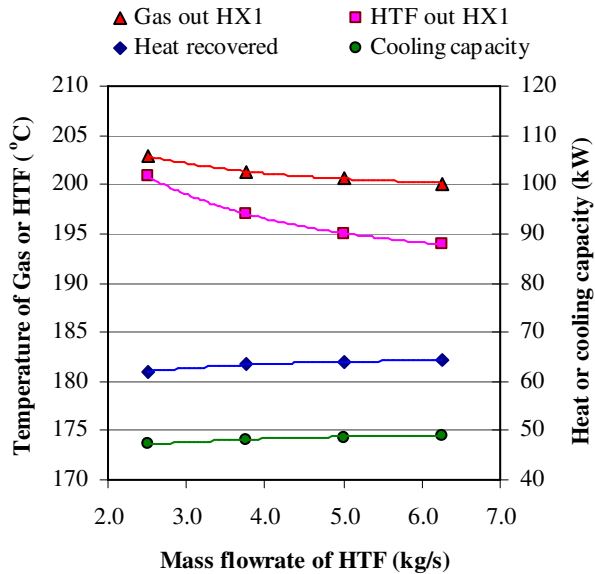

Figure 6: Heat recovered for generating cooling in the trigeneration plant

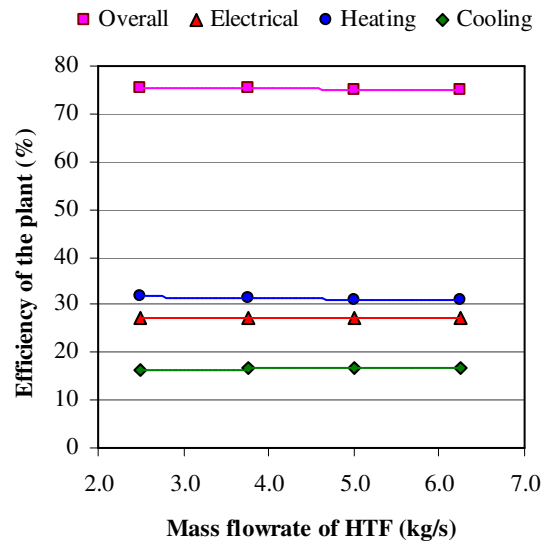

Figure 7: Efficiency of the trigeneration plant at different HTF mass flowrate

CONCLUSIONS

A commercially available gas fired ammonia-water absorption refrigeration system has been redesigned to operate in a trigeneration arrangement in conjunction with a microturbine based CHP system. The system utilises a heat transfer fluid for heat transfer between the CHP exhaust gas heat recovery system and the generator of the absorption system.

Best absorption refrigeration system performance was obtained with a HTF temperature to the generator of 195 °C. Based on the performance characteristics established in the laboratory the maximum refrigeration capacity of an 80 kW microturbine based trigeneration system was found to be 45 kW. The overall efficiency of such a system was determined to be 75%. System improvements can be achieved by using a higher efficiency CHP system and optimising the heat transfer circuit to reduce the pump power consumption.

ACKNOWLEDGEMENT

The authors acknowledge the financial support received from the Food Technology Unit of DEFRA for this project and the contribution of the industrial collaborators: Bond Retail Services Ltd, Apex Air Conditioning, Bowman Power and Doug Marriott Associates Ltd.

NOMENCLATURE

Symbol	Description	Symbol	Description
CFD	Computational fluid dynamics	Q_c	Cooling capacity (kW)
CHP	Combined heat and power	Q_g	Heat recovered in generator (kW)
COP	Coefficient of performance	Q_h	Heating capacity (kW)
COPs	COP system with HTF pump power considered	T_{oi}, T_{oo}	Temperature of HTF in and out (°C)
C_{pb}	Specific heat of brine (kJ/kgK)	\dot{V}	Fuel flowrate (m ³ /hr)
C_{po}	Specific heat of HTF (kJ/kgK)	T_{bi}, T_{bo}	Temperature of brine in and out (°C)
CRP	Combined refrigeration and power	W_e	Electrical power generation (kW)
CV	Caloric value of fuel (MJ/m ³)	W_f	Energy consumption rate of fuel (kW)
HX	Heat exchanger	W_{pump}	Pump power (kW)
HTF	Heat transfer fluid	η_e	Electrical efficiency (%)
\dot{m}_b, \dot{m}_o	Mass flowrate of brine and HTF (kg/s)	η_{TRI}	Overall efficiency of the trigeneration plant (%)

REFERENCES

1. Alalzadeh-Azar A A, Slayzak S J and Ryan J P, Evaluation of Cooling, Heating and Power (CHP) for Office Buildings, ASHRAE Transactions, Symposia, 2002, pp.1045-1051
2. Arteconi A, Brandoni C, and Polonara F, Distributed generation and trigeneration: Energy saving opportunities in Italian supermarket sector, Applied Thermal Engineering 29, 2009, 1735–1743
3. DTI, Meeting the Energy Challenge, A White Paper on Energy, 343 pgs. 2007, <http://www.berr.gov.uk>
4. Florides G A, Kalogirou S A, Tassou S A and Wrobel L C, Modelling and simulation of an absorption solar cooling system for Cyprus, Solar Energy, 2002, 72, 1, 43-51
5. Robur, Gas fired absorption chiller for cooling medium-large area: installation, use and maintenance manual, 7th ed, 2007, <http://www.robur.com>
6. Rossa J A, Matelli J A and Bazzo E, An experimental investigation of an ammonia-water absorption system associated to a micro-turbine, In: Proceedings of the International Conference on ECOS, 2007, Padova, Italy
7. Sugiarta N, Chaer I, Tassou S A and Marriott D, Assessment of a micro-gas turbine based trigeneration system in a supermarket, In: Proceedings of the International Conference on FTEC, 2006, Jakarta, Indonesia, ISSN 0854-9346
8. Tassou S A, Chaer I, Sugiarta N, Ge Y T and Marriott D, Application of tri-generation systems to the food retail industry, Energy Conversion and Management 48, 2007, 2988–2995
9. Tassou S A, Chaer I, Sugiarta N, Marriott D and Suamir IN, Trigeneration – a solution to efficient use of energy in the food industry, In: Proceedings of the Institute of Refrigeration, session 2007-2008, Proc Inst R 2007-08 7/1-16